

TAPEPRO

DRYWALL TOOLS

AIA
Adjustable Inside Applicator

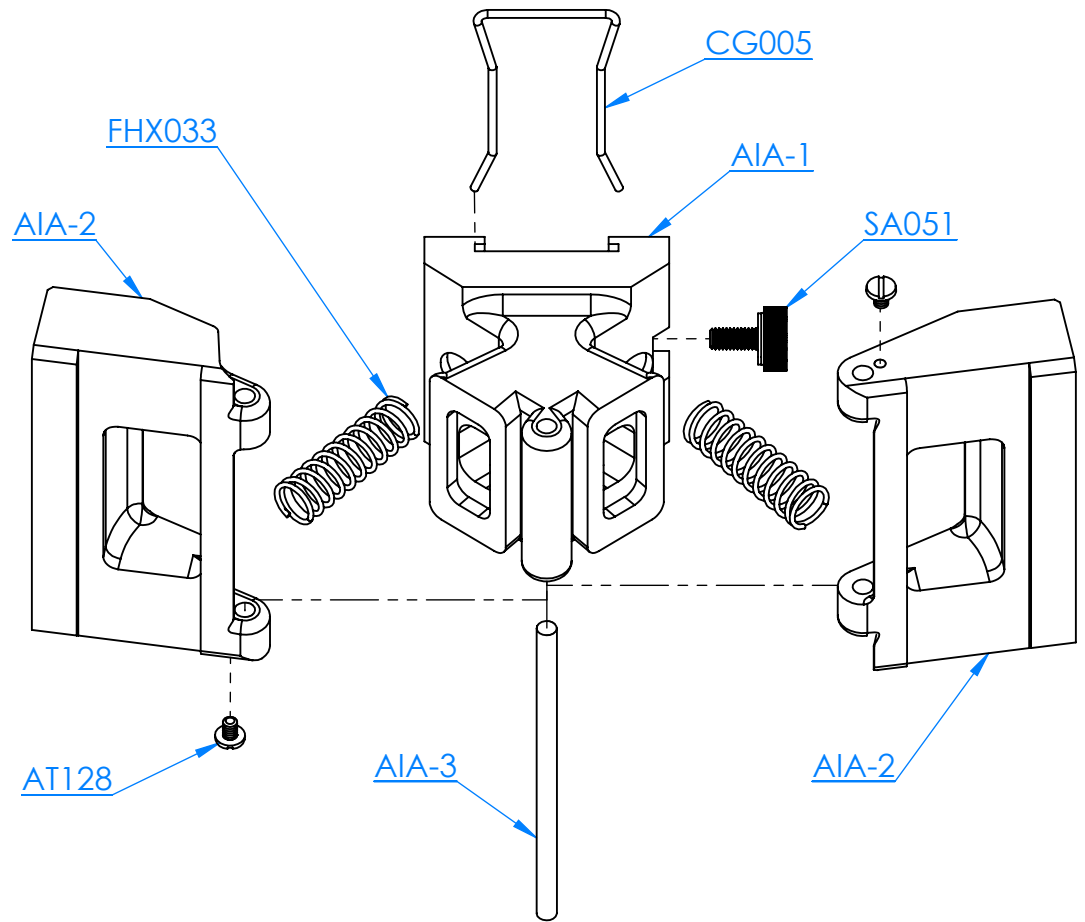
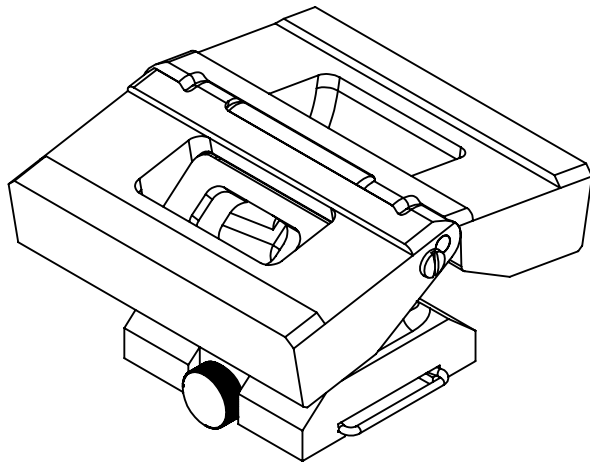

Part #	DESCRIPTION	QTY.
AIA-1	Body	1
AIA-2	AIA Wing	2
AIA-3	4 x 80mm SS Rod	1
CG005	Spring Retainer	1
FHX033	Brake Spring SS	2
AT128	4-40 x 5/32 BH Screw	2
SA051	10-32 X 1" Socket Cap	1

Effective as at 30 Apr 13